

## **Effects of Large-Scale Use of Compact Fluorescent Lamps in Nigerian Electrical Network**

Emeruwa, C., Abiodun, I.C.

*Department of Physics, Federal University Otuoke, Nigeria*

---

**Abstract:** *In recent times, Non-linear loads now flourish in homes, offices and within the industrial environment. These Non-linear loads form a key component of the total loading in a typical electrical network. The Compact Fluorescent Lamp (CFL) is a typical example of a non-linear load that essentially produces and introduces distorted currents into the electrical power network, which has the potency to create adverse consequences if appropriate and adequate harmonic alleviation techniques are not employed. CFLs are now a major component of the luminary market in Nigeria because of the obvious need to phase out Incandescent Lamps (ILs). However, there are genuine concerns over the quality of some CFLs in the market. This study examines and compares the quality of some major brands of CFLs, in terms of their working parameters such as power factor, harmonic content, fundamental power factor, apparent power and non-active power. The broader implication of these results is ascertained by looking into the effects Large Scale Installation of CFLs would have on a generalized electrical network. This study shows that CFLs with high harmonic currents raises the requirements of the source and other network components, as well as place a significant strain on them, since they draw a higher current and also consume a higher apparent power and non-active power than is required for normal power delivery. It is also found that voltage harmonic limits can exceed the IEEE limit of 5% as the number of CFLs deployed is increased. This situation is more manifest if CFLs with higher current harmonic content are deployed.*

**Keywords-***Compact Fluorescent Lamps, Harmonics, Non-linear Loads, Power Factor, Power Quality, Total Harmonic Distortion*

---

Date of Submission: 22-06-2019

Date of acceptance: 05-07-2019

---

### **I. Introduction**

Many governments around the world through their policies tend to ban the use of Incandescent Lamps (ILs) and completely replace them by other more energy efficient lamps. CFLs are one of the alternatives to ILs that have gained common acceptance primarily due to their relatively low power consumption, while delivering high lumen output. For instance, in terms of luminosity, a 5W CFL is equal to a 25W IL and a 14W CFL is equal to a 75W IL. This implies that large scale CFL use can be beneficial for utilities since it can result in peak shaving, increased system capacity, and significant savings in the medium and long term [1]. The transition from ILs to other types of lamps such as CFLs is also facilitated by the retrofitting into existing sockets for ILs. Another benefit of CFLs is their reputed longer lifetimes than ILs. However, a major drawback associated with CFL use is that they draw a significantly distorted current, due to an in-built diode bridge rectifier used to aid in the conversion of the incoming 50Hz Alternating Current to a much higher frequency of 20-40kHz, which is applied to the lamp tube. Therefore, when CFLs are deployed on a large scale in electrical networks, the quality of power therein can be adversely affected. Researchers have shown that CFLs generally have current distortions that are in excess of 100% which, depending on the particular network configuration and other connected loads, can cause harmonic limits at system buses and Point of Common Couplings (PCCs) to be exceeded [2][10]. However, it is first imperative that CFLs in the market be analyzed to verify their key performance parameters, inclusive of their harmonic current injections into the electrical network, which in turn can give an indication of the possible consequences if their usage is in large quantity. An excess of harmonics in the electrical network has a host of negative consequences, inclusive of increased line losses, thermal stresses on equipment, pulsating and reduced torque in motors and generators, and a shortening of equipment life [14]. Overall, high harmonic levels cause the quality of power on electric power networks to be significantly degraded. The primary aim of this study is to characterize, compare and evaluate the behavior of non-linear load, using CFLs as a case study. Focus is placed on analyzing the harmonic content of the major brands of CFLs. By extension, the possible effects on a representative portion of the electrical network when the CFLs are deployed on a large scale are investigated using MATLAB/Simulink.

## II. Algorithm For Computation Of Cfl Parameters

Harmonic levels for the supply voltage and CFL current up to the 50th order were entered into a MATLAB code used for displaying spectral, phase and time-domain plots of voltage and current, as well as computing various performance parameters for the tested CFLs. The algorithm for the MATLAB Code is given below, with formulae as defined in [15]. A sampling frequency of 300kHz was used throughout.

- (i) Input measured rms harmonic currents and phase angles for CFL-1.
- (ii) Input measured rms harmonic voltages and phase angles for CFL-1.
- (iii) Compute rms current using  $I_{rms} = \sqrt{\sum_h I_h^2}$ .
- (iv) Compute rms voltage using  $V_{rms} = \sqrt{\sum_h V_h^2}$ .
- (v) Compute apparent power using  $S = V_{rms} I_{rms}$ .
- (vi) Compute active power using  $P = \sum_h V_h I_h \cos\theta_h$ .
- (vii) Compute power factor using  $PF = P/S$ .
- (viii) Compute nonactive power using  $N = \sqrt{S^2 - P^2}$ .
- (ix) Compute total harmonic distortion for voltage and current using  $THD_{I,V} = \sqrt{(\sum_{h \neq 1} I_h^2)/I_1}, \sqrt{(\sum_{h \neq 1} V_h^2)/V_1}$
- (x) Compute distortion power factor using  $DPF = 1/\sqrt{1 + THD_1^2}$ .
- (xi) Display performance parameters and graphs of spectral and phase plots, voltage, current, and harmonic components in sinusoidal form.
- (xii) Repeat (i) to (xi) for CFL-2 to CFL-9.

Where:  $V_{rms}$  and  $I_{rms}$  are the rms values of the fundamental components of voltage and current respectively,  $V_h$  and  $I_h$  are the rms harmonic components of the voltage and current respectively,  $\theta_h$  is the phase angle between the voltage and current for the  $h^{th}$  harmonic.

## III. System Model

The broadrepercussion of the harmonic distortions due to the tested CFLs was investigated by using Simulink to model a simplified and generalized electrical network, where a lumped resistance was used to represent parallel-connected thermal or linear loads for all connected consumers. Specifically, an attempt was made to investigate the impact of large scale deployment of the CFLs on a generalized electrical network. Since our interest is strictly on the system's response due to CFLs, other harmonic-producing loads, such as arcing devices, switch mode power supplies, and variable speed drives, which comprise many electrical networks nowadays, have not been included since this may cause confounding of the results. This means that the results and conclusions of this study would represent best-case scenarios. The generalized system to be modeled and investigated is shown in Figure 1 below.

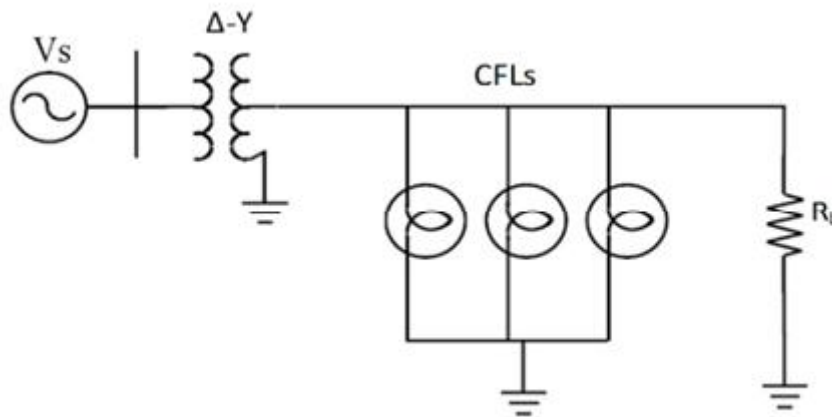

Fig. 1. System for Investigating the Impact of Large Scale CFL Deployment.

Since it allows for a general impression of what can happen in any electrical network using the type of CFLs tested in this study, this procedure was preferred to other methods, whose results would only be specific to the system under consideration. The voltage was supplied to the CFLs via the secondary of a 0.2MVA, 11kV/0.430kV,  $\Delta$ -Y transformer with a rated secondary current of 266.6A and an impedance voltage of 4.10%. The actual voltage used in the model is 223.5V rms at 50Hz since the CFLs were tested for their harmonic content at that voltage level. The line is assumed to be AWG10 aluminium of length 100m and resistance 0.330 $\Omega$ . For simplicity, the line is assumed to be a summation of the lengths of the various cables used to supply power to all consumers serviced by the transformer. Each CFL was modeled by current sources at the various

harmonic frequencies with non-zero current amplitudes. The phase angles and power consumption of the CFLs were also accounted for in the model. The impact of the CFLs on the network was investigated by progressively increasing the number of CFLs in the setup. The interaction and compensation of harmonic levels when various brands of CFLs are employed were also looked into.

**IV. CFL Characteristics**

The tabulated results of the measured CFL currents and the computed parameters for the two lamps, CFL-I and CFL-II, are shown in Table 1.

**Table 1.** Parameters for CFL-1 and CFL-2.

CFL	$I_{rms}(mA)$	$I_1(mA)$	P(W)	S(VA)	N(var)	$\theta_1(^{\circ})$	FPF	PF	THDI <sub>1</sub> (%)	DPF
CFL-1	47.449	24.300	5.129	10.538	9.548	24.4	0.913	0.485	155.612	0.555
CFL-2	23.604	22.200	5.114	5.172	1.300	10.3	0.883	0.969	17.317	0.977

The graph of spectral, phase and time domain of these two lamps, which have the highest and lowest current THD values respectively, are shown in Figures 2 and 3. All nine CFLs draw a non-sinusoidal current, with THDI values varying from 15.32% to 155.81%, of which four are in excess of 100%. All lamps except one have some low-amplitude even harmonics interspersed among the higher-amplitude odd harmonics. Power factors for the lamps varied from 0.48 to 0.95, with an average value of 0.73. High THDI values correlate with low power factor, with a general tendency for power factors to decrease with increasing harmonic current injections. All lamps with THDI values exceeding 100% had power factors less than or equal to 0.5. Fundamental power factors (FPFs) for all lamps were leading and in excess of 0.82, with a maximum value of 0.96 and an average value of 0.90. Since the supply voltage can practically be considered as a pure sinusoid, with THDV being 1.6% in all cases, the contribution of current harmonics to the power consumed by the CFLs is insignificant. More specifically, for all lamps, only the fundamental component [1-3] contributes to the active power, with the other current components serving only to increase the requirements of the voltage source. For those lamps with THDI values in excess of 100%, the superfluous harmonic currents are all in excess of 10mA, with the fundamental component [1] being much less than the total rms current. With large scale installation of CFLs, especially those with higher harmonic content, the excess current draw and the strain on the voltage source would be considerably high.

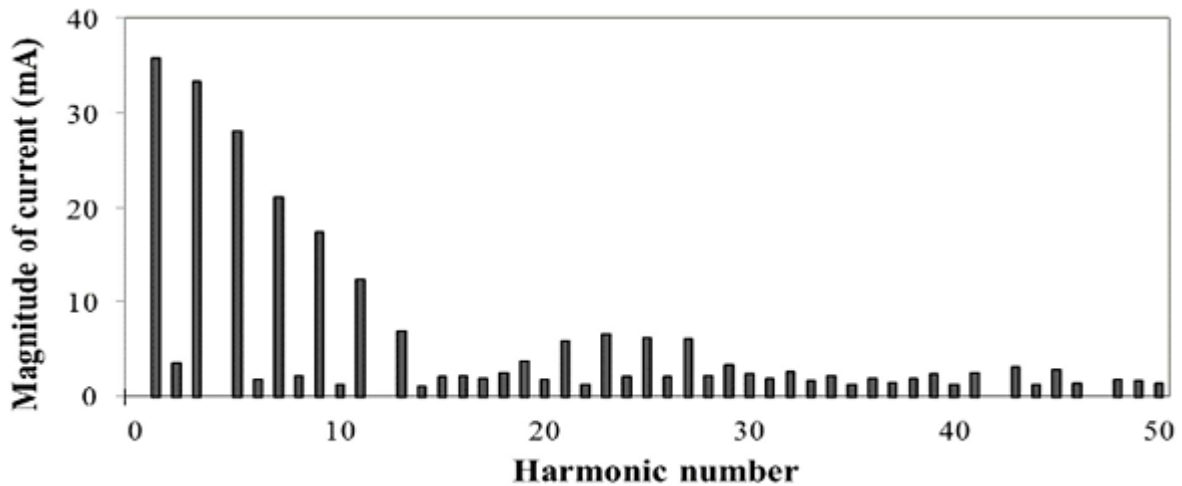

**Fig. 2.** Plot of CFL-1 current Spectral

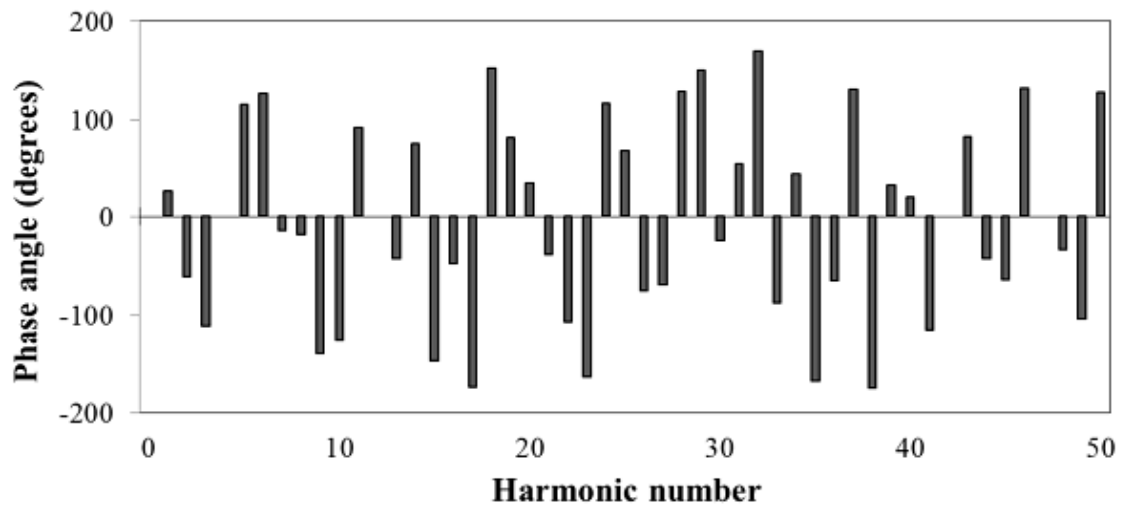

Fig. 3. Plot of CFL-1 current Phase angle

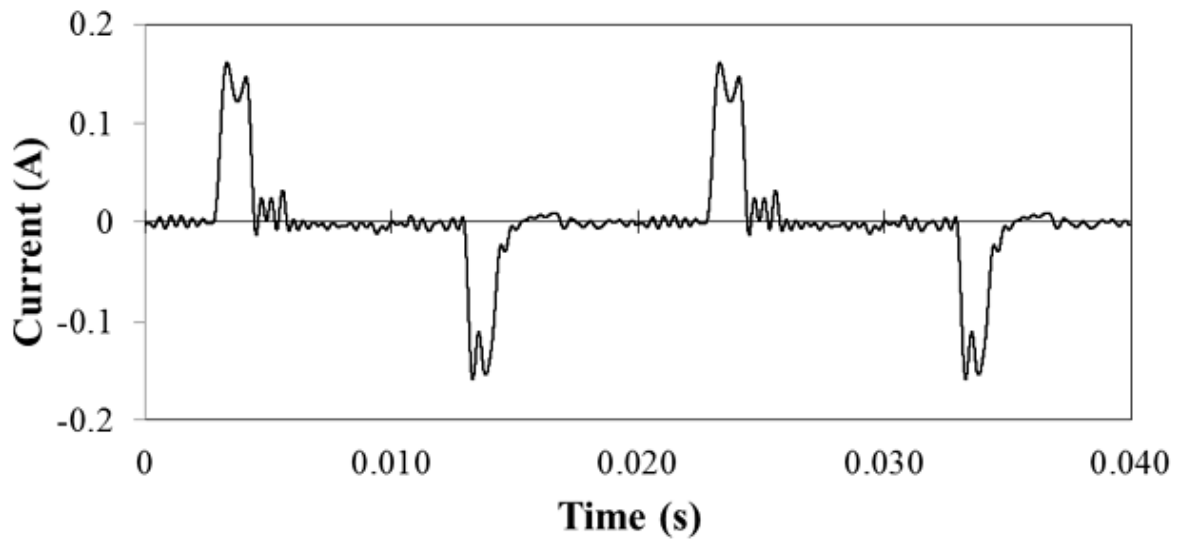

Fig. 4. Plot of CFL-1 current Time domain.

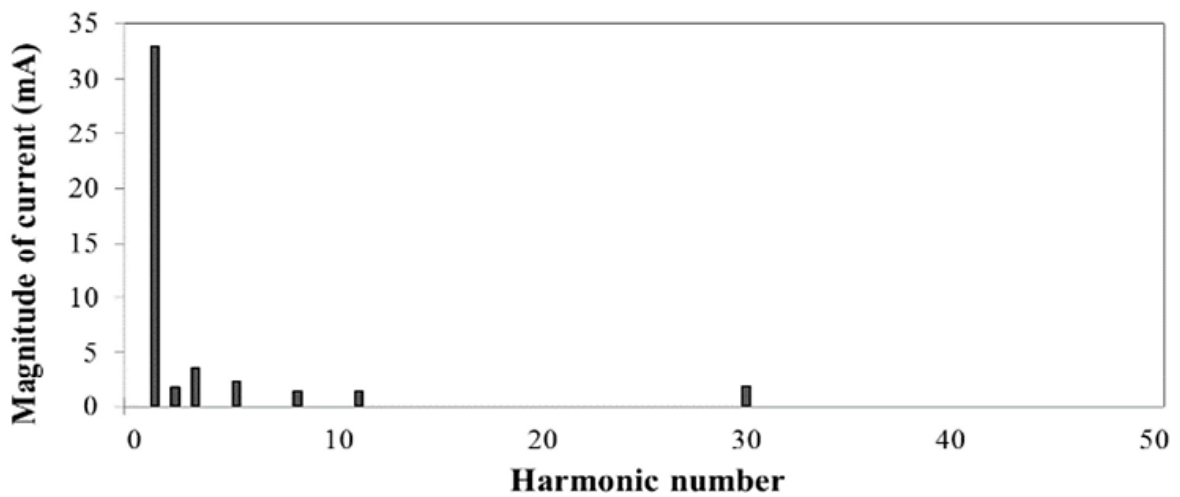

Fig. 5. Plot of CFL-2 current Spectral

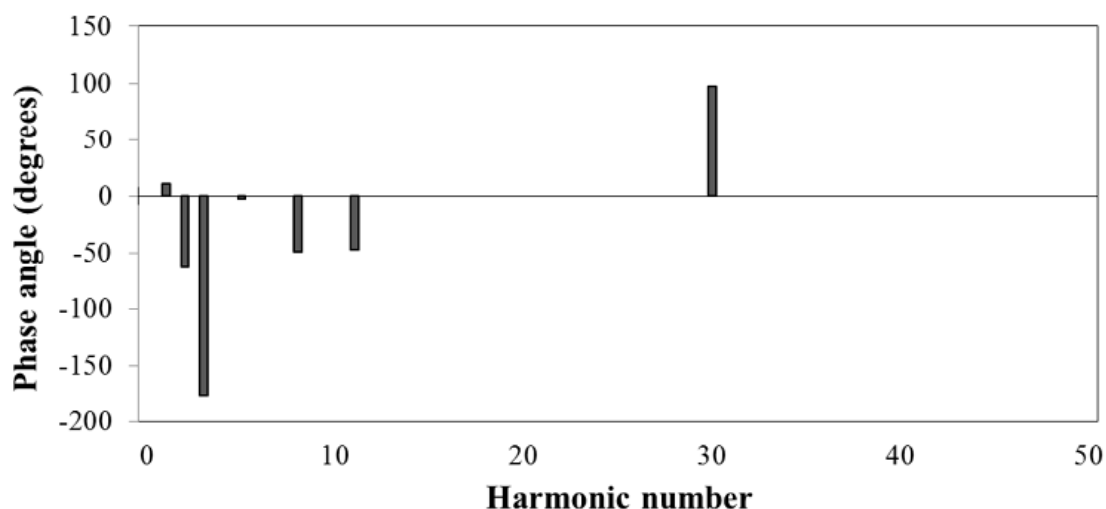

Fig. 6. Plot of CFL-2 current Phase angle

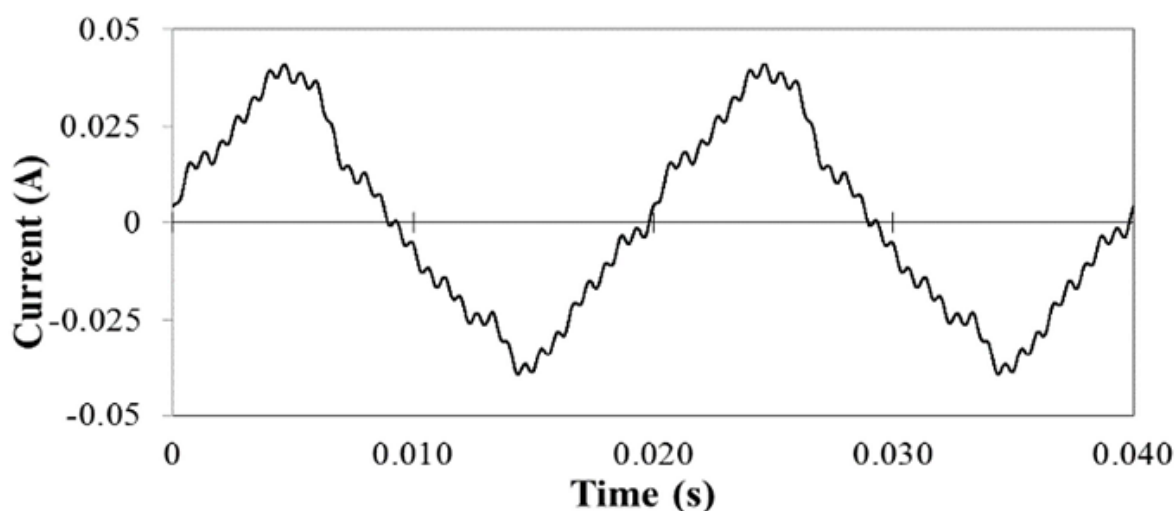

Fig. 7. Plot of CFL-2 current Time domain.

### V. Effects Of CFLS On The Generalized Electrical Network

The effects of gradually escalating the number of CFLs in an electrical network are examined for two cases:

(1) Case I: CFL-1 only

The effect of increasing the number of CFL-1 lamps, which have the highest current THD value of 155.810%, is first investigated. Two cases are examined:

(i) When CFLs comprise the only load in the system and they are gradually escalated, there is no change in the THDV values across the network impedances and the THDI values of the current flowing through them. They all remain constant at a value of 155.810%. However, the magnitude of harmonic current injected into the system increases in proportion to the amount of CFLs deployed, which would be a concern when CFLs form a significant portion of the total system loading.

(ii) When the other parallel loads are a lumped resistance of value 100Ω. Gradually escalating the number of CFLs from 50 to 1500, results in an increase in the THDV values across the parallel resistive load. This is shown in Figure 8. The recommended IEEE voltage harmonic limit of 5% is exceeded when approximately 750 CFLs are deployed. The losses on the 100m line due to the harmonic currents vary from 8mW to 0.24W as the number of CFLs varies from 50 to 1500.

(2) Case II: CFLs with Different THD Values

The effects of two different combinations of CFLs are examined. These are:

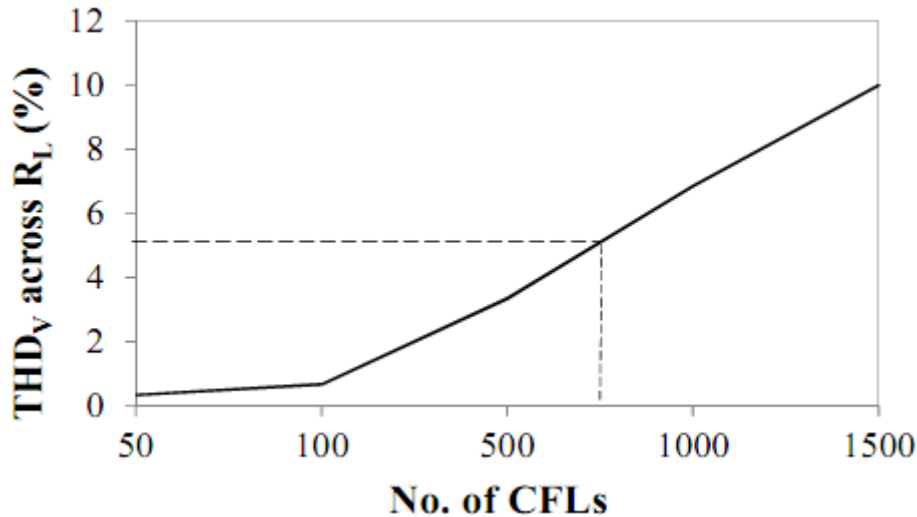

Fig. 8. Variation of the harmonic voltage levels across the lumped resistive load RL with increasing CFL-1.

(i) When CFL-1 and CFL-2 form the only loads in the system, and they are progressively increased, there is no change in the THDV values across the system impedances and the THDI values of the current flowing through them. They all remain constant at a value of 83.52%. However, the magnitude of harmonic current injected into the system increases in proportion to the amount of CFLs deployed. Similarly, progressively increasing the numbers of CFL-1, CFL-2 and CFL-7 maintains the THDV and THDI values constant, but at a lower value of 63.38%.

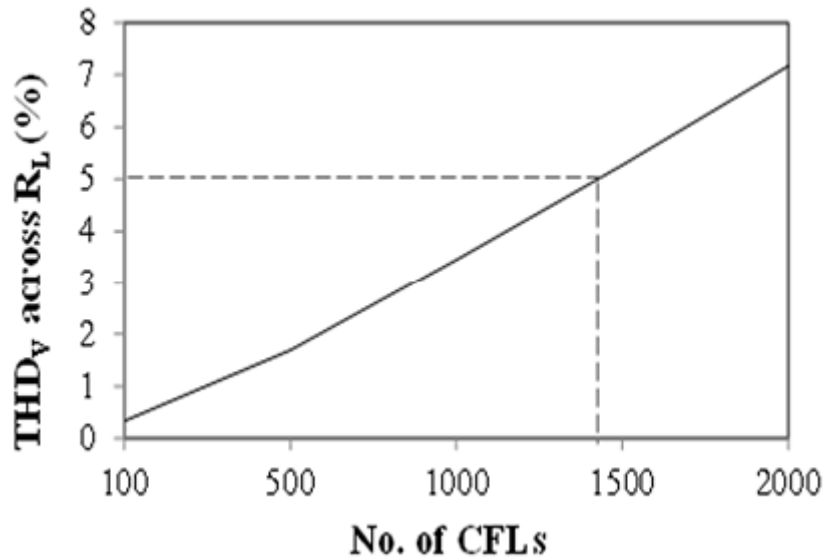
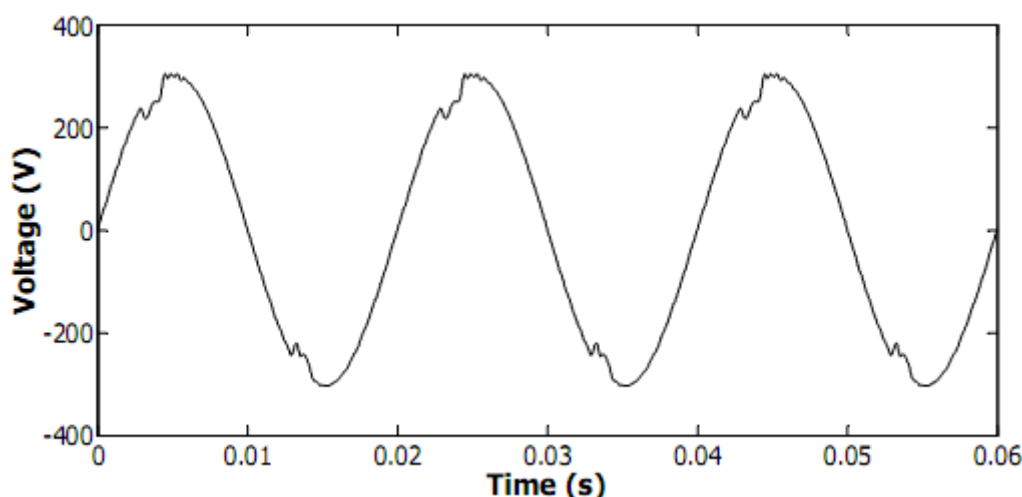

Fig. 9. Variation of the harmonic voltage levels across the lumped resistive load RL with increasing CFL-1 and CFL-9.

ii) Progressively increasing the numbers of CFL-1 and CFL-2 from 100 to 2000, with an equal deployment for both types of lamps on each iteration, results in an increase in the THDV values across the parallel resistive load from 0.33% to 7.17%. The recommended IEEE voltage harmonic limit of 5% is exceeded when approximately 1450 CFLs, consisting of an equal number of CFL-1 and CFL-2, are deployed (Figure 9). The limit is attained when the CFLs comprise 19.27% of the total possible system loading. The voltage waveform across the load and the PCC when the recommended harmonic voltage limit is just about exceeded is shown in Figure 10. The losses on the 100m line due to the harmonic currents vary from 8mW to 0.16W as the number of CFLs varies from 100 to 2000.

When the numbers of CFL-1, CFL-2 and CFL-7 are progressively increased from 300 to 3000, the harmonic voltage distortion across the lumped resistive load RL varies from 0.74% to 8.24%. The THDV limit across RL is attained when the total number of CFLs is approximately 1950, consisting of 650 each of the three types of

CFLs (Figure 11). The CFL loading at this point represents 23.26% of the maximum possible system loading. The voltage waveform when the harmonic voltage at the PCC just about exceeds the recommended limit of 5% is similar to that shown in Figure 10. The losses on the 100m line due to the harmonic currents vary from 16.2mW to 162mW as the number of CFLs varies from 300 to 3000.



**Fig. 10.** Distorted voltage across RL when CFL-1 = CFL-2 = 750.

## **VI. Discussion**

Out of nine (9) tested CFLs, four (4) had a THDI value exceeding 100%, implying a correspondingly low power factor and highly distorted current waveform. Such lamps draw a higher current than necessary for their rated power and hence shorten the effective capacity of the distribution system. The foregoing is cause for concern since the nine (9) brands considered in this study represent a significant portion of the branded CFLs in the Indian market. It implies that widespread use of CFLs will result in a significant amount of harmonic currents being injected into the electrical network. The lumped resistance RL considered in this study is representative only of thermal loads connected to the distribution transformer considered as the voltage source in this study. The harmonic currents of the CFLs due to any number of consumers would propagate through the network impedances and cause voltage distortion at the Point of Common Coupling (PCC) and across the linear loads of other consumers. Thus, the distorted voltage at the PCC, due to the CFLs in the system, is also the voltage across RL. For simplicity, other harmonic-producing loads which form a significant portion of most electrical networks nowadays have been neglected in this study. Therefore, it is logical to assume that harmonic levels in the simplified network model considered in this study are conservative and much higher voltage distortion levels should be present. This study also shows that harmonic levels due to CFLs with high THDI values will be offset somewhat by CFLs with much lower THDI values. Thus, under conditions where sales of the various brands of CFLs are more or less equal, adverse consequences of large scale CFL use would be somewhat lessened. However, if the market share is dominated by CFLs with low power factors, then the quality of power would be affected.

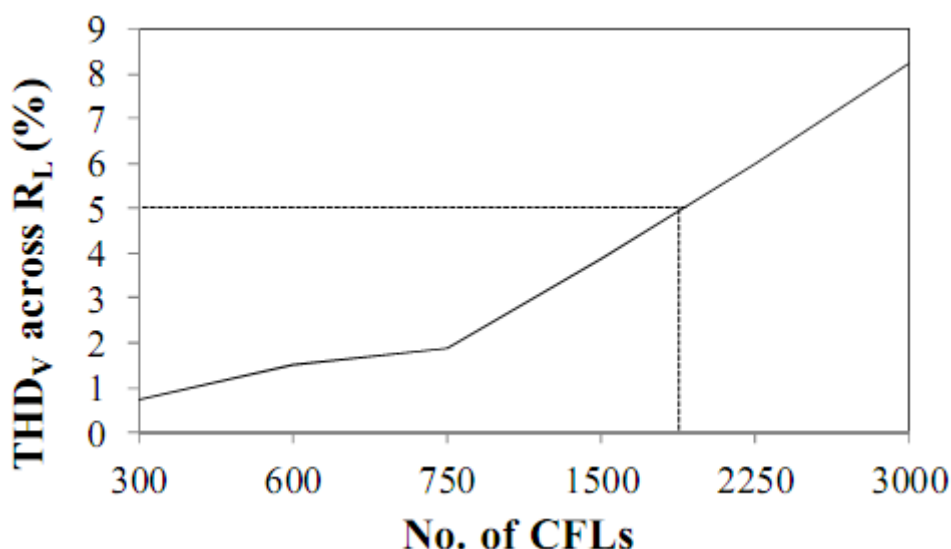

**Fig. 11.** Variation of the harmonic voltage levels across the lumped resistive load RL when CFL-1, CFL-7 and CFL-9 are increased.

Line losses due to harmonic currents have the potential to approach high levels and are also a source of concern. When a line is much longer than the 100m length used in this study, there would be significantly greater resistance and line losses. Over the last few years, the number of CFLs manufactured in India has been steadily rising. While the number for other types of lamps, LEDs excepted, has more or less remained constant, the amount of CFLs manufactured has steadily increased from 67 million in 2005 to 453 million in 2013 [18]. And based on the situation in other countries around the world, there is every indication that CFL production in Nigeria will continue to rise. Thus, the quality of CFLs manufactured in Nigeria, and harmonic levels at key points in the electrical network must be continually monitored so that, if needs be, mitigation strategies can be implemented.

## VII. Conclusion

The main conclusions of this study are:

- (1) The proliferation of Compact Fluorescent Lamps with inadequate or no power factor correction circuitries in the in the Nigerian market is a situation that can, over time, significantly contribute to high harmonic current levels and degradation of the quality of power in the electrical network.
- (2) To reduce harmonic levels and their adverse effects,harmonic interaction and mitigation among Compact Fluorescent Lamps, and other non-linear loads as well, in electrical networks will go a long way.

## References

- [1]. M. Abbaspour and A. H. Jahanikia, "Power quality considerations in the widespread use of compact fluorescent lamps", Proceedings of the 10th IEEE International Conference on Electrical Power Quality and Utilisation (EPQU), pp. 1-6, Sept. 2009.
- [2]. Janak Acharya and Alexandre B. Nassif, "An investigation on the harmonic attenuation effect of modern compact fluorescent lamps", Proceedings of the 13th IEEE International Conference on Harmonics and Quality of Power (ICHQP), Sept. 2008.
- [3]. Jordi Cunill-Sola and Miquel Salichs, "Study and characterisation of waveforms from low watt (<25W) compact fluorescent lamps with electronic ballasts", IEEE Transactions on Power Delivery, pp. 2305-2311, Oct. 2007.
- [4]. R. A. Jabbar et al, "Impact of Compact Fluorescent Lamp on Power Quality", Proceedings of the Australasian Universities Power Engineering Conference (AUPEC), pp. 1-5, Paper P-025, December 2008.
- [5]. A.F. Abd El-Gawad, "Studying the impact of different lighting loads on both harmonics and power factor", Proceedings of the 42nd International Universities Power International Conference (UPEC), pp. 109-114, Sept. 2007.
- [6]. S.G. Abeyratne and K. D. A. Munasinghe, "Power quality and harmonic loads", Proceedings of the 1st IEEE International Conference on Industrial and Information Systems (ICIIS), pp. 52-57, August 2007.
- [7]. M. Akmal, R. Arif and S.A. Qureshi, "Power quality based comparison of compact fluorescent lamp with fluorescent light", Proceedings of the 3rd International Conference on Electrical Engineering (ICEE), pp. 1-6, April 2009.
- [8]. M. Maksic and D. Matvoz, "Impact of compact fluorescent lamps on the electric power network", Proceedings of the 13th IEEE International Conference on Harmonics and Quality of Power (ICHQP), Sept. 2008.
- [9]. F.V. Topalis et al., "Influence of large-scale installation of energy saving lamps on the line voltage distortion of a weak network supplied by photovoltaic station", IEEE Transactions on Power Delivery, vol. 19, no. 4, pp. 1787-1793, October 2004.
- [10]. M. Rawa, D. Thomas and M. Sumner, "Experimental Measurements and Computer Simulations of FL and CFL Lamps for Harmonic Studies", Proceedings of the 2014 UKSim-AMSS 16th International Conference on Computer Modelling and Simulation, pp. 335-339, March 2014.
- [11]. Debanka De, S. Sahana, B. Roy, "Performance analysis of fluorescent and LED light system", 2016 International Conference on Computer, Electrical & Communication Engineering (ICCECE), December 2016.



- [12]. N. Milardovich et al, "On the reduction of the third-order harmonic losses in low-voltage power cables used for feeding large LED and CFL lighting loads", *Journal of Advanced Electromagnetics*, vol. 6, no. 3, pp. 46-52, October 2017.
- [13]. J. Molina and L. Saintz, "Compact Fluorescent Lamp Modeling for Large-Scale Harmonic Penetration Studies", *IEEE Transactions on Power Delivery*, pp. 1523-1531, October 2014.
- [14]. IEEE Std. 519-1992, "Recommended practices and requirements for harmonic control in electrical power systems", New York, USA, April 1993.
- [15]. IEEE Working Group on Nonsinusoidal Situations: Effects on Meter Performance and Definitions of Power, "Practical definitions for powers in systems with nonsinusoidal waveforms and unbalanced loads:A Discussion", *IEEE Transactions on Power Delivery*, vol. 11, no. 1, pp. 79-101, January 1996.
- [16]. R. Gilleskie and W. M. Grady, "Harmonics and how they relate to power factor", *Proceedings of the Electric Power Research Institute (EPRI) Power Quality Issues and Opportunities Conference (PQA '93)*, November 1993.
- [17]. J. N. Gill and G. S. Punekar, "Implications of the Large Scale Deployment of Non-Linear Loads", *Journal of Electrical and Electronic Engineering*, vol 6(6), pp. 153-159, September 2018
- [18]. ELCOMA – Electric Lamp and Component Manufacturers of India [Online] Available: <http://www.elcomaindia.com/>. (Accessed: March 13, 2011, September 23, 2018).

Emeruwa, C. " Effects of Large-Scale Use of Compact Fluorescent Lamps in Nigerian Electrical Network." *IOSR Journal of Electronics and Communication Engineering (IOSR-JECE)* 14.3 (2019): 22-30.